









# CORDOBA



<b>A</b>  <b>M8</b> 24 PCS	<b>B</b>  <b>M8X20</b> 16 PCS	<b>C</b>  <b>M8X25</b> 4 PCS	<b>D</b>  <b>M8X45</b> 4 PCS	<b>E</b>  4 PCS	<b>F</b>  5# 1 PC
<b>1</b>  1 PC	<b>2</b>  4 PCS	<b>3</b>  2 PCS			

## 2

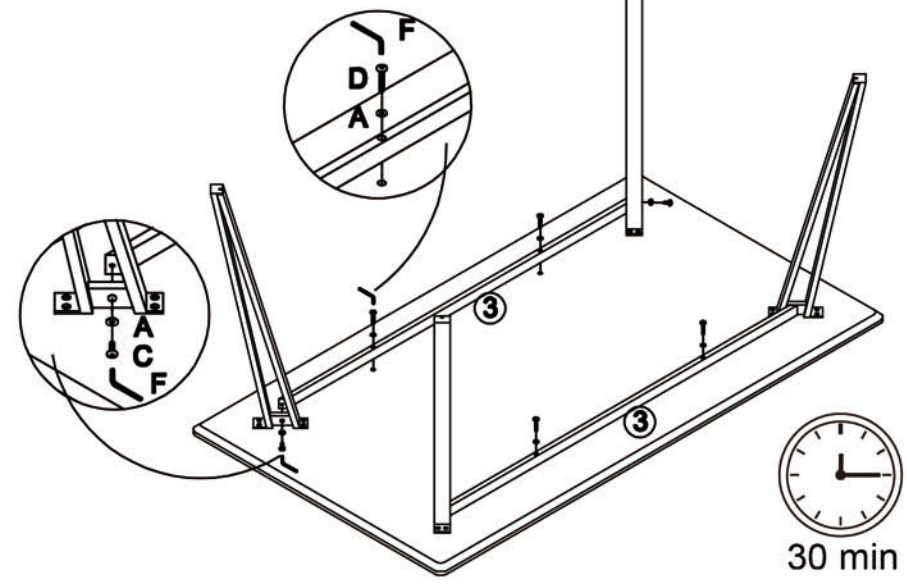

## 1

